

2GB Fully Buffered DIMM

EBE21FD4AGFD EBE21FD4AGFN

Specifications

- Density: 2GB
- Organization
 - 256M words × 72 bits, 2 ranks
- Mounting 36 pieces of 512M bits DDR2 SDRAM sealed in FBGA
- Package
 - 240-pin fully buffered, socket type dual in line memory module (FB-DIMM)
 - PCB height: 30.35mm
 - Lead pitch: 1.00mm
 - Advanced Memory Buffer (AMB): 655-ball FCBGA
 - Lead-free (RoHS compliant)
- Power supply
 - DDR2 SDRAM: VDD = 1.8V ± 0.1V
 - AMB: VCC = 1.5V + 0.075V/-0.045
- Data rate: 667Mbps/533Mbps (max.)
- Four internal banks for concurrent operation (components)
- Interface: SSTL_18
- Burst lengths (BL): 4, 8
- /CAS Latency (CL): 3, 4, 5
- Precharge: auto precharge option for each burst access
- Refresh: auto-refresh, self-refresh
- Refresh cycles: 8192 cycles/64ms
 - Average refresh period
 - 7.8μs at 0°C ≤ TC ≤ +85°C
 - 3.9μs at +85°C < TC ≤ +95°C
- Operating case temperature range
 - TC = 0°C to +95°C

Features

- JEDEC standard Raw Card E Design
- Industry Standard Advanced Memory Buffer (AMB)
- High-speed differential point-to-point link interface at 1.5V (JEDEC draft spec)
 - 14 north-bound (NB) high speed serial lanes
 - 10 south-bound (SB) high speed serial lanes
- Various features/modes:
 - MemBIST and IBIST test functions
 - Transparent mode and direct access mode for DRAM testing
 - Interface for a thermal sensor and status indicator
- Channel error detection and reporting
- Automatic DDR2 SDRAM bus and channel calibration
- SPD (serial presence detect) with 1piece of 256 byte serial EEPROM

Note: Warranty void if removed DIMM heat spreader.

Performance

System clock frequency	FB-DIMM		DDR2 SDRAM		
	Speed grade	Peak channel throughput	FB-DIMM link data rate	Speed Grade	DDR data rate
167MHz	PC2-5300F	8.0GByte/s	4.0Gbps	DDR2-667 (5-5-5)	667Mbps
133MHz	PC2-4200F	6.4GByte/s	3.2Gbps	DDR2-533 (4-4-4)	533Mbps

Ordering Information

Part number	DIMM speed grade	Component JEDEC speed bin (CL-tRCD-tRP)	Package	Mounted devices*
EBE21FD4AGFD-6E-E	PC2-5300F	DDR2-667 (5-5-5)	240-pin FB-DIMM	EDE5104AGSE-6E-E
EBE21FD4AGFD-5C-E	PC2-4200F	DDR2-533 (4-4-4)		EDE5104AGSE-6E-E EDE5104AGSE-5C-E
EBE21FD4AGFN-6E-E	PC2-5300F	DDR2-667 (5-5-5)	240-pin FB-DIMM	EDE5104AGSE-6E-E
EBE21FD4AGFN-5C-E	PC2-4200F	DDR2-533 (4-4-4)		EDE5104AGSE-6E-E EDE5104AGSE-5C-E

Note: Please refer to the EDE5104AGSE, EDE5108AGSE datasheet (E0715E) for detailed operation part and timing waveforms

Part Number

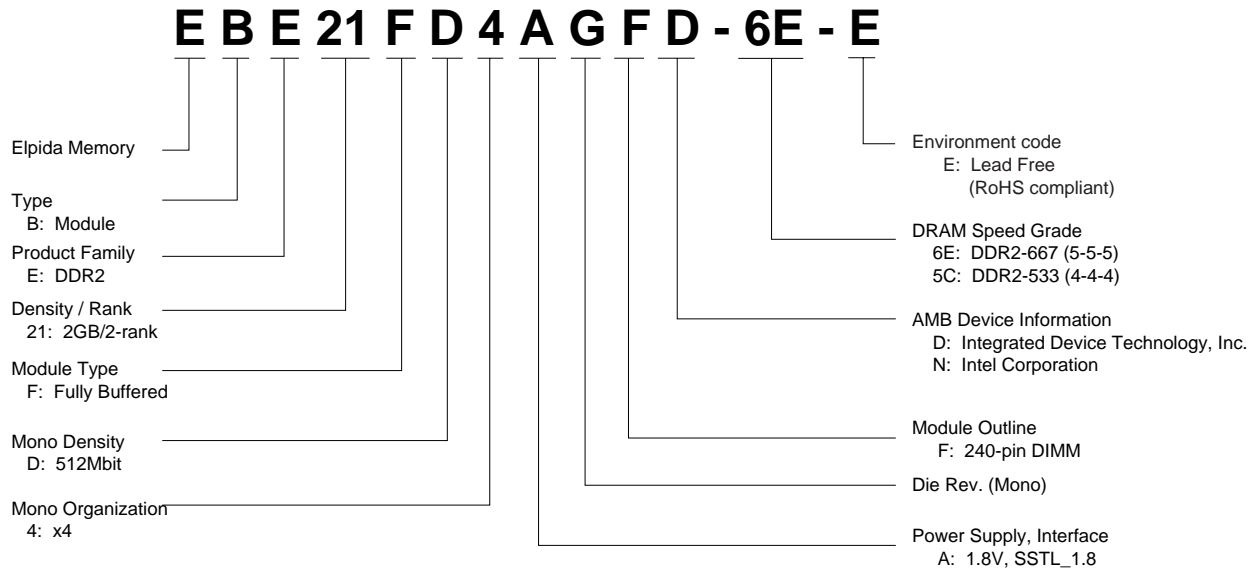

Advanced Memory Buffer Overview

The Advanced Memory Buffer (AMB) reference design complies with the FB-DIMM Architecture and Protocol Specification. It supports DDR2 SDRAM main memory. The AMB allows buffering of memory traffic to support large memory capacities. All memory control for the DRAM resides in the host, including memory request initiation, timing, refresh, scrubbing, sparing, configuration access, and power management. The AMB interface is responsible for handling FB-DIMM channel and memory requests to and from the local DIMM and for forwarding requests to other DIMMs on the FB-DIMM channel.

The FB-DIMM provides a high memory bandwidth, large capacity channel solution that has a narrow host interface. FB-DIMMs use commodity DRAMs isolated from the channel behind a buffer on the DIMM. The memory capacity is 288 devices per channel and total memory capacity scales with DRAM bit density.

The AMB is the buffer that isolates the DRAMs from the channel.

Advanced Memory Buffer Functionality

The AMB will perform the following FB-DIMM channel functions.

- Supports channel initialization procedures as defined in the initialization chapter of the FB-DIMM Architecture and Protocol Specification to align the clocks and the frame boundaries, verify channel connectivity, and identify AMB DIMM position.
- Supports the forwarding of southbound and northbound frames, servicing requests directed to a specific AMB or DIMM, as defined in the protocol chapter, and merging the return data into the northbound frames.
- If the AMB resides on the last DIMM in the channel, the AMB initializes northbound frames.
- Detects errors on the channel and reports them to the host memory controller.
- Support the FB-DIMM configuration register set as defined in the register chapters.
- Acts as DRAM memory buffer for all read, write, and configuration accesses addressed to the DIMM.
- Provides a read buffer FIFO and a write buffer FIFO.
- Supports an SMBus protocol interface for access to the AMB configuration registers.
- Provides logic to support MemBIST and IBIST design for test functions.
- Provides a register interface for the thermal sensor and status indicator.
- Functions as a repeater to extend the maximum length of FB-DIMM links.

Advanced Memory Buffer Block Diagram

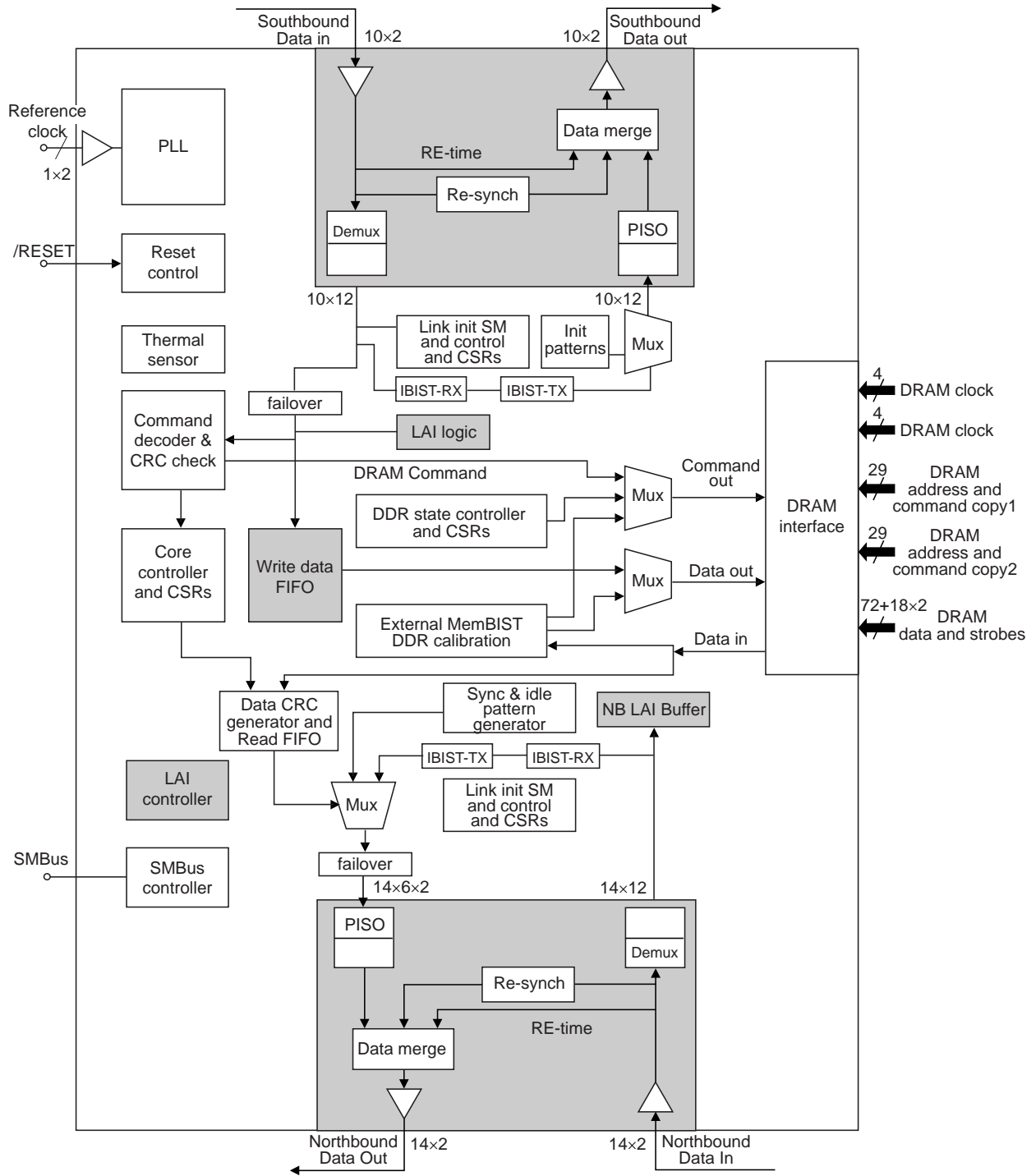

Note: This figure is a conceptual block diagram of the AMB's data flow and clock domains.

Interfaces

Figure Block Diagram AMB Interfaces shows the AMB and all of its interfaces. They consist of two FB-DIMM links, one DDR2 channel and an SMBus interface. Each FB-DIMM link connects the AMB to a host memory controller or an adjacent FB-DIMM. The DDR2 channel supports direct connection to the DDR2 SDRAMs on a FB-DIMM.

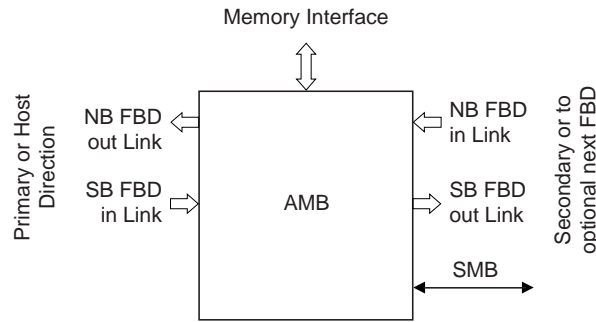

Block Diagram AMB Interfaces

Interface Topology

The FB-DIMM channel uses a daisy-chain topology to provide expansion from a single DIMM per channel to up to 8 DIMMs per channel. The host sends data on the southbound link to the first DIMM where it is received and re-driven to the second DIMM. On the southbound data path each DIMM receives the data and again re-drives the data to the next DIMM until the last DIMM receives the data. The last DIMM in the chain initiates the transmission of data in the direction on the host (a.k.a. northbound). On the northbound data path each DIMM receives the data and re-drives the data to the next DIMM until the host is reached.

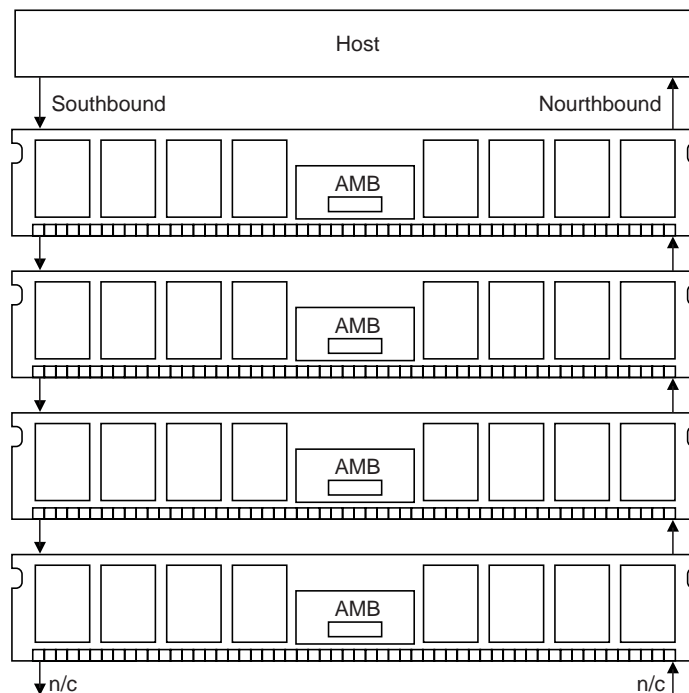

Block Diagram FB-DIMM Channel Southbound and Northbound Paths

High-Speed Differential Point-to-Point Link (at 1.5 V) Interfaces

The AMB supports one FB-DIMM channel consisting of two bidirectional link interfaces using high-speed differential point-to-point electrical signaling. The southbound input link is 10 lanes wide and carries commands and write data from the host memory controller or the adjacent DIMM in the host direction. The southbound output link forwards this same data to the next FB-DIMM. The northbound input link is 14 lanes wide and carries read return data or status information from the next FB-DIMM in the chain back towards the host. The northbound output link forwards this information back towards the host and multiplexes in any read return data or status information that is generated internally. Data and commands sent to the DRAMs travel southbound on 10 primary differential signal line pairs. Data received from the DRAMs and status information travel northbound on 14 primary differential pairs. Data and commands sent to the adjacent DIMM upstream are repeated and travel further southbound on 10 secondary differential pairs. Data and status information received from the adjacent DIMM upstream travel further northbound on 14 secondary differential pairs.

DDR2 Channel

The DDR2 channel on the AMB supports direct connection to DDR2 SDRAMs. The DDR2 channel supports two ranks of eight banks with 16 row/column request, 64 data, and eight check-bit signals. There are two copies of address and command signals to support DIMM routing and electrical requirements. Four transfer bursts are driven on the data and check-bit lines at 800MHz. Propagation delays between read data/check-bit strobe lanes on a given channel can differ. Each strobe can be calibrated by hardware state machines using write/read trial and error. Hardware aligns the read data and check-bits to a single core clock. The AMB provides four copies of the command clock phase references (CLK [3:0]) and write data/check-bit strobes (DQSs) for each DRAM nibble.

SMBus Slave interface

The AMB supports an SMBus interface to allow system access to configuration register independent of the FB-DIMM link. The AMB will never be a master on the SMBus, only a slave. Serial SMBus data transfer is supported at 100kHz. SMBus access to the AMB may be a requirement to boot and to set link strength, frequency and other parameters needed to insure robust configurations. It is also required for diagnostic support when the link is down. The SMBus address straps located on the DIMM connector are used by the unique ID.

Block Diagram

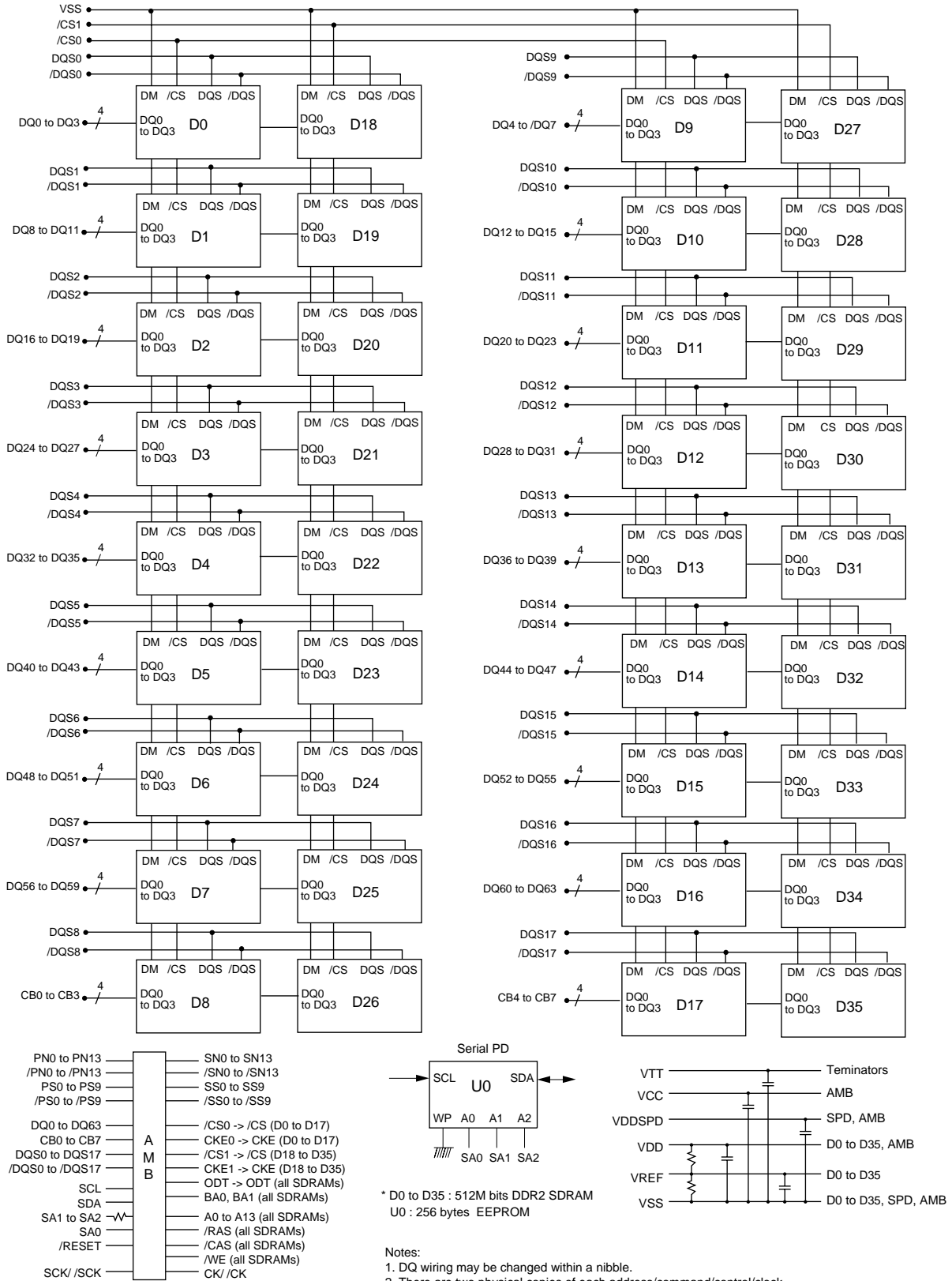

Pin Configurations

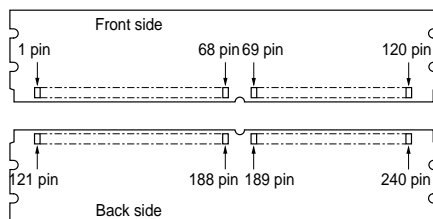

Front side

No.	Name	No.	Name	No.	Name	No.	Name
1	VDD	36	VSS	71	/PS0	106	NC
2	VDD	37	PN5	72	VSS	107	VSS
3	VDD	38	/PN5	73	PS1	108	VDD
4	VSS	39	VSS	74	/PS1	109	VDD
5	VDD	40	PN13	75	VSS	110	VSS
6	VDD	41	/PN13	76	PS2	111	VDD
7	VDD	42	VSS	77	/PS2	112	VDD
8	VSS	43	VSS	78	VSS	113	VDD
9	VCC	44	NC	79	PS3	114	VSS
10	VCC	45	NC	80	/PS3	115	VDD
11	VSS	46	VSS	81	VSS	116	VDD
12	VCC	47	VSS	82	PS4	117	VTT
13	VCC	48	PN12	83	/PS4	118	SA2
14	VSS	49	/PN12	84	VSS	119	SDA
15	VTT	50	VSS	85	VSS	120	SCL
16	VID1	51	PN6	86	NC		
17	/RESET	52	/PN6	87	NC		
18	VSS	53	VSS	88	VSS		
19	NC	54	PN7	89	VSS		
20	NC	55	/PN7	90	PS9		
21	VSS	56	VSS	91	/PS9		
22	PN0	57	PN8	92	VSS		
23	/PN0	58	/PN8	93	PS5		
24	VSS	59	VSS	94	/PS5		
25	PN1	60	PN9	95	VSS		
26	/PN1	61	/PN9	96	PS6		
27	VSS	62	VSS	97	/PS6		
28	PN2	63	PN10	98	VSS		
29	/PN2	64	/PN10	99	PS7		
30	VSS	65	VSS	100	/PS7		
31	PN3	66	PN11	101	VSS		
32	/PN3	67	/PN11	102	PS8		
33	VSS	68	VSS	103	/PS8		
34	PN4	69	VSS	104	VSS		
35	/PN4	70	PS0	105	NC		

Back side

No.	Name	No.	Name	No.	Name	No.	Name
121	VDD	156	VSS	191	/SS0	226	NC
122	VDD	157	SN5	192	VSS	227	VSS
123	VDD	158	/SN5	193	SS1	228	SCK
124	VSS	159	VSS	194	/SS1	229	/SCK
125	VDD	160	SN13	195	VSS	230	VSS
126	VDD	161	/SN13	196	SS2	231	VDD
127	VDD	162	VSS	197	/SS2	232	VDD
128	VSS	163	VSS	198	VSS	233	VDD
129	VCC	164	NC	199	SS3	234	VSS
130	VCC	165	NC	200	/SS3	235	VDD
131	VSS	166	VSS	201	VSS	236	VDD
132	VCC	167	VSS	202	SS4	237	VTT
133	VCC	168	SN12	203	/SS4	238	VDDSPD
134	VSS	169	/SN12	204	VSS	239	SA0
135	VTT	170	VSS	205	VSS	240	SA1
136	VID0	171	SN6	206	NC		
137	M_TEST	172	/SN6	207	NC		
138	VSS	173	VSS	208	VSS		
139	NC	174	SN7	209	VSS		
140	NC	175	/SN7	210	SS9		
141	VSS	176	VSS	211	/SS9		
142	SN0	177	SN8	212	VSS		
143	/SN0	178	/SN8	213	SS5		
144	VSS	179	VSS	214	/SS5		
145	SN1	180	SN9	215	VSS		
146	/SN1	181	/SN9	216	SS6		
147	VSS	182	VSS	217	/SS6		
148	SN2	183	SN10	218	VSS		
149	/SN2	184	/SN10	219	SS7		
150	VSS	185	VSS	220	/SS7		
151	SN3	186	SN11	221	VSS		
152	/SN3	187	/SN11	222	SS8		
153	VSS	188	VSS	223	/SS8		
154	SN4	189	VSS	224	VSS		
155	/SN4	190	SS0	225	NC		

Pin Description

Pin name	Pin Type	Function
SCK, /SCK	Input	System clock input
PN0 to PN13, /PN0 to /PN13	Output	Primary northbound data
PS0 to PS9, /PS0 to /PS9	Input	Primary southbound data
SN0 to SN13, /SN0 to /SN13	Input	Secondary northbound data
SS0 to SS9, /SS0 to /SS9	Output	Secondary southbound data
SCL	Input	Serial presence detect (SPD) clock input
SDA	Input / Output	SPD data and AMB SMBus address/data
SA0 to SA2* ¹	Input	SPD address inputs
VID0 to VID1* ²	Input	Voltage ID
/RESET	Input	AMB reset signal
M_TEST* ³	Input	VREF margin test input
NC	—	No connection
VCC	Power supply	AMB core power and AMB channel interface power (1.5V)
VDD	Power supply	DRAM power and AMB DRAM I/O power (1.8V)
VTT	Power supply	DRAM address, Command and clock termination voltage (VDD/2)
VDDSPD	Power supply	SPD power (3.3V)
VSS	—	Ground

- Notes: 1. They are also used to select the DIMM number in the AMB.
 2. These pins must be unconnected.
 3. Don't connect in a system.

Electrical Specifications

- All voltages are referenced to VSS (GND).

Absolute Maximum Ratings

Parameter	Symbol	Value	Unit	Note
Voltage on any pin relative to VSS	VIN/VOUT	-0.3 to +1.75	V	
AMB core power voltage relative to VSS	VCC	-0.3 to +1.75	V	
DRAM interface power voltage relative to VSS	VDD	-0.5 to +2.30	V	
Termination voltage relative to VSS	VTT	-0.5 to +2.30	V	
Storage temperature	Tstg	-55 to +100	°C	

Caution

Exposing the device to stress above those listed in Absolute Maximum Ratings could cause permanent damage. The device is not meant to be operated under conditions outside the limits described in the operational section of this specification. Exposure to Absolute Maximum Rating conditions for extended periods may affect device reliability.

Operating Temperature Conditions

Parameter	Symbol	Value	Unit	Note
SDRAM component case temperature	TC_DRAM	0 to +95	°C	1
AMB component case temperature	TC_AMB	110	°C	

Note: 1. Supporting 0°C to +85°C and being able to extend to +95°C with doubling auto-refresh commands in frequency to a 32ms period (tREFI = 3.9µs) and higher temperature self-refresh entry via the control of EMRS (2) bit A7 is required.

DC Operating Conditions

Parameter	Symbol	min.	typ.	max.	Unit	Note
AMB supply voltage	VCC	1.455	1.50	1.575	V	
DDR2 SDRAM supply voltage	VDD	1.7	1.8	1.9	V	
Input termination voltage	VTT	0.48 × VDD	0.50 × VDD	0.52 × VDD	V	
EEPROM supply voltage	VDDSPD	3.0	3.3	3.6	V	
SPD input high voltage	VIH (DC)	2.1	—	VDDSPD	V	1
SPD input low voltage	VIL (DC)	—	—	0.8	V	1
RESET input high voltage	VIH (DC)	1.0	—	—	V	2
RESET input low voltage	VIL (DC)	—	—	0.5	V	2
Leakage current (RESET)	IL	-90	—	90	µA	2
Leakage current (link)	IL	-5	—	5	µA	3

- Notes: 1. Applies for SMB and SPD bus signals.
 2. Applies for AMB CMOS signal /RESET.
 3. For all other AMB related DC parameters, please refer to the high-speed differential link interface specification.

AMB Component Timing

For purposes of IDD testing, the following parameters are to be utilized.

Parameter	Symbol	min.	typ.	max.	Units	Note
EI Assertion pass-thru timing	tEI propagate	—	—	4	clks	
EI deassertion pass-thru timing	tEID	—	—	bit lock	clks	
EI assertion duration	tEI	100	—	—	clks	
Resample pass-thru time		—	TBD	—	ns	
Resynch pass-thru Time		—	TBD	—	ns	
Bit lock Interval	tBitLock	—	—	119	frames	
Frame lock Interval	tFrameLock	—	—	154	frames	

Note: 1. The EI stands for "Electrical Idle".

Power Specification Parameter and Test Conditions

Frequency (Mbps)			-6E	-5C			
			667	533			
Parameter	Symbol	Power Supply	max.	max.	Unit	Conditions	Note
Idle Current, single or last DIMM	Idd_Idle_0	@1.5V	2.60	2.20	A	L0 state, idle (0 BW) Primary channel enabled, Secondary channel disabled	CKE high. Command and address lines stable. DRAM clock active.
		@1.8V	2.81	2.59	A		
		Total	8.58	7.53	W		
Idle Current, first DIMM	Idd_Idle_1	@1.5V	3.40	3.00	A	L0 state, idle (0 BW) Primary and secondary channels enabled	CKE high. Command and address lines stable. DRAM clock active.
		@1.8V	2.80	2.57	A		
		Total	9.81	8.75	W		
Active Power	Idd_Active_1	@1.5V	3.90	3.40	A	L0 state	50% DRAM BW, 67% read, 33% write. Primary and secondary channels enabled. DRAM clock active, CKE high.
		@1.8V	5.41	5.36	A		
		Total	15.56	14.69	W		
Active Power, data pass through	Idd_Active_2	@1.5V	3.70	3.20	A	L0 state	50% DRAM BW to downstream DIMM, 67% read, 33% write. Primary and secondary channels enabled. CKE high. Command and address lines stable. DRAM clock active.
		@1.8V	2.32	2.14	A		
		Total	9.39	8.25	W		
Training	Idd_Training (for AMB spec. Not in SPD)	@1.5V	4.00	3.50	A	Primary and secondary channels enabled. 100% toggle on all channel lanes DRAMs idle. 0 BW.	CKE high, Command and address lines stable. DRAM clock active.
		@1.8V	2.63	2.40	A		
		Total	10.44	9.22	W		

Reference Clock Input Specifications*1

Parameter	Symbol	min.	max.	Units	Notes
Reference clock frequency@ 3.2Gb/s (nominal 133.33MHz)	fRefclk-3.2	126.67	133.40	MHz	2, 3, 4
Reference clock frequency@ 4.0 Gb/s (nominal 166.67MHz)	fRefclk-4.0	158.33	166.75	MHz	2, 3, 4
Single-ended maximum voltage	Vmax	—	1.15	V	5, 7
Single-ended minimum voltage	Vmin	-0.3	—	V	5, 8
Differential voltage high	VRefclk-diff-ih	150	—	mV	6
Differential voltage low	VRefclk-diff-il	—	-150	mV	6
Absolute crossing point	VCross	250	550	mV	5, 9, 10
VCross variation	VCross-delta	—	140	mV	5, 9, 11
AC common mode	VSCK-cm-acp-p	—	225	mV	12
Rising and falling edge rates	ERRefclk-diff-Rise, ERRefclk-diff-Fall	0.6	4.0	V/ns	6, 13
% Mismatch between rise and fall edge rates	ERRefclk-Match	—	20	%	6, 14
Duty cycle of reference clock	TRefclk-Dutycycle	40	60	%	6
Ringback voltage threshold	VRB-diff	-100	100	mV	6, 15
Allowed time before ringback	TStable	500	—	ps	6, 15
Clock leakage current	II_CK	-10	10	μA	16, 17
Clock input capacitance	CI_CK	0.5	2.0	pF	17
Clock input capacitance delta	CI_CK (Δ)	-0.25	0.25	pF	Difference between RefClk and RefClk# input capacitance
Transport delay	TD	—	5	ns	18, 19
	NSAMPLE	10 ¹²	—	periods	20
Reference clock jitter (rms), filtered	TREF-JITTER-RMS	—	3.0	ps	21, 22
Reference clock jitter (peak-to-peak) due to spectrum clocking effects	TREF-SSCp-p	—	30	ps	
Reference clock jitter difference between adjacent AMB	TREF-JITTER-DELTA	—	TBD	ps	

- Notes: 1. For details, refer to the JEDEC specification “FB-DIMM High Speed Differential PTP Link at 1.5V”.
- The nominal reference clock frequency is determined by the data frequency of the link divided by 2 times the fixed PLL multiplication factor for the FB-DIMM channel (6:1). $f_{data} = 2000\text{MHz}$ for a 4.0Gbps FB-DIMM channel and so on.
 - Measured with SSC disabled. Enabling SSC will reduce the reference clock frequency.
 - Not all FB-DIMM agents will support all frequencies; compliance to the frequency specifications is only required for those data rates that are supported by the device under test.
 - Measurement taken from single-ended waveform.
 - Measurement taken from differential waveform.
 - Defined as the maximum instantaneous voltage including overshoot.
 - Defined as the minimum instantaneous voltage including undershoot.
 - Measured at the crossing point where the instantaneous voltage value of the rising edge of REFCLK+ equals the falling edge of REFCLK-.
 - Refers to the total variation from the lowest crossing point to the highest, regardless of which edge is crossing. Refers to all crossing points for this measurement.
 - Defined as the total variation of all crossing voltages of rising REFCLK+ and falling REFCLK-. This is the maximum allowed variance in for any particular system.
 - The majority of the reference clock AC common mode occurs at high frequency (i.e., the reference clock frequency).

13. Measured from -150mV to $+150\text{mV}$ on the differential waveform. The signal must be monotonic through the measurement region for rise and fall time. The 300mV measurement window is centered on the differential 0V crossing.
14. Edge rate matching applies to rising edge rate for REFCLK+ and falling edge rate for REFCLK-. It is measured using a $\pm 75\text{mV}$ window centered on the median cross point where REFCLK+ rising meets REFCLK- falling. The median crosspoint is used to calculate the voltage thresholds the oscilloscope uses for the edge rate calculations. The rising edge rate of REFCLK+ should be compared to the falling edge rate of REFCLK-. The maximum allowed difference should not exceed 20% of the slowest edge
15. Tstable is the time the differential clock must maintain a minimum $\pm 150\text{mV}$ differential voltage after rising /falling edges before it is allowed to droop back into the $\pm 100\text{mV}$ differential range.
16. Measured with a single-ended input voltage of 1V .
17. Applies to RefClk and RefClk#.
18. This parameter is not a direct clock output parameter but it indirectly determines the clock output parameter TREF-JITTER.
19. The net transport delay is the difference in time of flight between associated data and clock paths. The data path is defined from the reference clock source, through the TX, to data arrival at the data sampling point in the RX. The clock path is defined from the reference clock source to clock arrival at the same sampling point. The path delays are caused by copper trace routes, on-chip routing, on-chip buffering, etc. They include the time-of-flight of interpolators or other clock adjustment mechanisms. They do not include the phase delays caused by finite PLL loop bandwidth because these delays are modeled by the PLL transfer functions.
20. Direct measurement of phase jitter records over NSAMPLE periods may be impractical. It is expected that the jitter will be measured over a smaller, yet statistically significant, sample size and the total jitter at NSAMPLE samples extrapolated from an estimate of the sigma of the random jitter components.
21. Measured with SSC enabled on reference clock generator.
22. As "measured" after the phase jitter filter. This number is separate from the receiver jitter budget that is defined by the TRX-Total-MIN parameters.

Differential Transmitter Output Specifications*1

Parameter	Symbol	min.	max.	Unit	Comments
Differential peak-to-peak output voltage for large voltage swing	VTX-DIFFp-p_L	900	1300	mV	$VTX-DIFFp-p = 2 \times VTX-D+ - VTX-D- $ Measured as note 2
Differential peak-to-peak output voltage for regular voltage swing	VTX-DIFFp-p_R	800	—	mV	$VTX-DIFFp-p = 2 \times VTX-D+ - VTX-D- $ Measured as note 2
Differential peak-to-peak output voltage for small voltage swing	VTX-DIFFp-p_S	520	—	mV	$VTX-DIFFp-p = 2 \times VTX-D+ - VTX-D- $ Measured as note 2
DC common code output voltage for large voltage swing	VTX-CM_L	—	375	mV	Defined as: $VTX-CM = DC (avg) of VTX-D+ + VTX-D- /2$ Measured as note 2
DC common code output voltage for small voltage swing	VTX-CM_S	135	280	mV	Defined as: $VTX-CM = DC (avg) of VTX-D+ + VTX-D- /2$ Measured as note 2. See also note 3
De-emphasized differential output voltage ratio for -3.5dB de-emphasis	VTX-DE-3.5-Ratio	-3.0	-4.0	dB	2, 4, 5
De-emphasized differential output voltage ratio for -6dB de-emphasis	VTX-DE-6.0-Ratio	-5.0	-7.0	dB	2, 4, 5
AC peak-to-peak common mode output voltage for large swing	VTX-CM-ACp-p L	—	90	mV	$VTX-CM-AC = \text{Max } VTX-D+ + VTX-D- /2 - \text{Min } VTX-D+ + VTX-D- /2$ Measured as note 2. See also note 6
AC peak-to-peak common mode output voltage for regular swing	VTX-CM-ACp-p R	—	80	mV	$VTX-CM-AC = \text{Max } VTX-D+ + VTX-D- /2 - \text{Min } VTX-D+ + VTX-D- /2$ Measured as note 2. See also note 6
AC peak-to-peak common mode output voltage for small swing	VTX-CM-ACp-p S	—	70	mV	$VTX-CM-AC = \text{Max } VTX-D+ + VTX-D- /2 - \text{Min } VTX-D+ + VTX-D- /2$ Measured as note 2. See also note 6
Maximum single-ended voltage in EI condition, DC + AC	VTX-IDLE-SE	—	50	mV	7, 8
Maximum single-ended voltage in EI condition, DC only	VTX-IDLE-SE-DC	—	20	mV	7, 8, 9
Maximum peak-to-peak differential voltage in EI condition	VTX-IDLE-DIFFp-p	—	40	mV	8
Single-ended voltage (w.r.t.VSS) on D+/D-	VTX-SE	-75	750	mV	2, 10
Minimum TX eye width	TTX-Eye-MIN	0.7	—	UI	2, 11, 12
Maximum TX deterministic jitter	TTX-DJ-DD	—	0.2	UI	2, 11, 12, 13
Instantaneous pulse width	TTX-PULSE	0.85	—	UI	14
Differential TX output rise/fall time	TTX-RISE, TTX-FALL	30	90	ps	Given by 20%-80% voltage levels. Measured as note 2
Mismatch between rise and fall times	TTX-RF-MISMATCH	—	20	ps	
Differential return loss	RLTX-DIFF	8	—	dB	Measured over 0.1GHz to 2.4GHz. See also note 15
Common mode return loss	RLTX-CM	6	—	dB	Measured over 0.1GHz to 2.4GHz. See also note 15

Parameter	Symbol	min.	max.	Unit	Comments
Transmitter termination resistance	RTX	41	55	Ω	16
D+/D- TX resistance difference	RTX-Match-DC	—	4	%	RTX-Match-DC = $2 \times RTX-D+ - RTX-D- / (RTX-D+ + RTX-D-)$ Bounds are applied separately to high and low output voltage states
Lane-to-lane skew at TX	LTX-SKEW 1	—	100 + 3UI	ps	17, 19
Lane-to-lane skew at TX	LTX-SKEW 2	—	100 + 2UI	ps	18, 19
Maximum TX Drift (resync mode)	TTX-DRIFT-RESYNC	—	240	ps	20
Maximum TX Drift (resample mode only)	TTX-DRIFT-RESAMPLE	—	120	ps	20
Bit Error Ratio	BER	—	10 ⁻¹²		21

- Notes:
- For details, refer to the JEDEC specification “FB-DIMM High Speed Differential PTP Link at 1.5V”.
 - Specified at the package pins into a timing and voltage compliance test load. Common-mode measurements to be performed using a 101010 pattern.
 - The transmitter designer should not artificially elevate the common mode in order to meet this specification.
 - This is the ratio of the VTX-DIFFp-p of the second and following bits after a transition divided by the VTX-DIFFp-p of the first bit after a transition.
 - De-emphasis shall be disabled in the calibration state.
 - Includes all sources of AC common mode noise.
 - Single-ended voltages below that value that are simultaneously detected on D+ and D- are interpreted as the Electrical Idle condition.
 - Specified at the package pins into a voltage compliance test load. Transmitters must meet both single-ended and differential output EI specifications.
 - This specification, considered with VRX-IDLE-SE-DC, implies a maximum 15mV single-ended DC offset between TX and RX pins during the electrical idle condition. This in turn allows a ground offset between adjacent FB-DIMM agents of 26mV when worst case termination resistance matching is considered.
 - The maximum value is specified to be at least $(VTX-DIFFp-p L / 4) + VTX-CM L + (VTX-CM-ACp-p / 2)$
 - This number does not include the effects of SSC or reference clock jitter.
 - These timing specifications apply to resync mode only.
 - Defined as the dual-dirac deterministic jitter.
 - Pulse width measured at 0 V differential.
 - One of the components that contribute to the deterioration of the return loss is the ESD structure which needs to be carefully designed.
 - The termination small signal resistance; tolerance across voltages from 100mV to 400mV shall not exceed $\pm 5\Omega$. with regard to the average of the values measured at 100mV and at 400mV for that pin.
 - Lane to Lane skew at the Transmitter pins for an end component.
 - Lane to Lane skew at the Transmitter pins for an intermediate component (assuming zero Lane to Lane skew at the Receiver pins of the incoming PORT).
 - This is a static skew. An FB-DIMM component is not allowed to change its lane to lane phase relationship after initialization.
 - Measured from the reference clock edge to the center of the output eye. This specification must be met across specified voltage and temperature ranges for a single component. Drift rate of change is significantly below the tracking capability of the receiver.
 - BER per differential lane.

Differential Receiver Input Specifications*1

Parameter	Symbol	min.	max.	Unit	Comments
Differential peak-to-peak input voltage	VRX-DIFFp-p	170	1300	mV	$VRX-DIFFp-p = 2 \times VRX-D+ - VRX-D- $ Measured as note 2
Maximum single-ended voltage for EI condition (AC + DC)	VRX-IDLE-SE	—	65	mV	3, 4, 5, 6
Maximum single-ended voltage for EI condition (DC only)	VRX-IDLE-SE-DC	—	35	mV	3, 4, 5, 6, 7
Maximum peak-to-peak differential voltage for EI condition	VRX-IDLE-DIFFp-p	—	65	mV	4, 5, 6
Single-ended voltage (w.r.t. VSS) on D+/D-	VRX-SE	-300	900	mV	5
Single-pulse peak differential input voltage	VRX-DIFF-PULSE	85	—	mV	5, 8
Amplitude ratio between adjacent symbols, $1100mV < VRX-DIFFp-p \leq 1300mV$	VRX-DIFF-ADJ RATIO- HI	—	3.0		5, 9
Amplitude ratio between adjacent symbols, $VRX-DIFFp-p \leq 1100mV$	VRX-DIFF-ADJ RATIO	—	4.0		5, 9
Maximum RX inherent timing error	TRX-TJ-MAX	—	0.4	UI	5, 10, 11
Maximum RX inherent deterministic timing error	TRX-DJ-DD	—	0.3	UI	5, 10, 11, 12
Single-pulse width at zero-voltage crossing	TRX-PW-ZC	0.55	—	UI	5, 8
Single-pulse width at minimum-level crossing	TRX-PW-ML	0.2	—	UI	5, 8
Differential RX input rise/fall time	TRX-RISE, TRX-FALL	50	—	ps	Given by 20%-80% voltage levels.
Common mode of the input voltage	VRX-CM	120	400	mV	Defined as: $VRX-CM = DC$ (avg) of $ VRX-D+ + VRX-D- /2$ Measured as note 2. See also note 13
AC peak-to-peak common mode of input voltage	VRX-CM-ACp-p	—	270	mV	$VRX-CM-AC =$ $Max VRX-D+ + VRX-D- /2 -$ $Min VRX-D+ + VRX-D- /2$ Measured as note 2
Ratio of VRX-CM-ACp-p to minimum VRX-DIFFp-p	VRX-CM-EH-Ratio	—	45	%	14
Differential return loss	RLRX-DIFF	9	—	dB	Measured over 0.1GHz to 2.4GHz. See also note 15
Common mode return loss	RLRX-CM	6	—	dB	Measured over 0.1GHz to 2.4GHz. See also note 15
RX termination resistance	RRX	41	55	Ω	16
D+/D- RX resistance difference	RRX-Match-DC	—	4	%	$RRX-Match-DC =$ $2 \times RRX-D+ - RRX-D- / (RRX-D+ + RRX-D-)$
Lane-to-lane PCB skew at Rx	LRX-PCB-SKEW	—	6	UI	Lane-to-lane PCB skew at the receiver that must be tolerated. See also note 17
Minimum RX Drift Tolerance	TRX-DRIFT	400	—	ps	18
Minimum data tracking 3dB bandwidth	FTRK	0.2	—	MHz	19
Electrical idle entry detect time	TEI-ENTRY - DETECT	—	60	ns	20
Electrical idle exit detect time	TEI-EXIT -DETECT	—	30	ns	
Bit Error Ratio	BER	—	10^{-12}		21

- Notes:
1. For details, refer to the JEDEC specification "FB-DIMM High Speed Differential PTP Link at 1.5V".
 2. Specified at the package pins into a timing and voltage compliant test setup. Note that signal levels at the pad will be lower than at the pin.
 3. Single-ended voltages below that value that are simultaneously detected on D+ and D- are interpreted as the Electrical Idle condition. Worst-case margins are determined by comparing EI levels with common mode levels during normal operation for the case with transmitter using small voltage swing.
 4. Multiple lanes need to detect the EI condition before the device can act upon the EI detection.
 5. Specified at the package pins into a timing and voltage compliance test setup.
 6. Receiver designers may implement either single-ended or differential EI detection. Receivers must meet the specification that corresponds to the implemented detection circuit.
 7. This specification, considered with VTX-IDLE-SE-DC, implies a maximum 15mV single-ended DC offset between TX and RX pins during the electrical idle condition. This in turn allows a ground offset between adjacent FB-DIMM agents of 26mV when worst case termination resistance matching is considered.
 8. The single-pulse mask provides sufficient symbol energy for reliable RX reception. Each symbol must comply with both the single-pulse mask and the cumulative eye mask.
 9. The relative amplitude ratio limit between adjacent symbols prevents excessive inter-symbol interference in the Rx. Each symbol must comply with the peak amplitude ratio with regard to both the preceding and subsequent symbols.
 10. This number does not include the effects of SSC or reference clock jitter.
 11. This number includes setup and hold of the RX sampling flop.
 12. Defined as the dual-dirac deterministic timing error.
 13. Allows for 15mV DC offset between transmit and receive devices.
 14. The received differential signal must satisfy both this ratio as well as the absolute maximum AC peak-to-peak common mode specification. For example, if VRX-DIFFp-p is 200mV, the maximum AC peak-to-peak common mode is the lesser of $(200\text{mV} \times 0.45 = 90\text{mV})$ and VRX-CM-ACp-p.
 15. One of the components that contribute to the deterioration of the return loss is the ESD structure which needs to be carefully designed.
 16. The termination small signal resistance; tolerance across voltages from 100mV to 400mV shall not exceed $\pm 5\Omega$. with regard to the average of the values measured at 100mV and at 400mV for that pin.
 17. This number represents the lane-to-lane skew between TX and RX pins and does not include the transmitter output skew from the component driving the signal to the receiver. This is one component of the end-to-end channel skew in the AMB specification.
 18. Measured from the reference clock edge to the center of the input eye. This specification must be met across specified voltage and temperature ranges for a single component. Drift rate of change is significantly below the tracking capability of the receiver.
 19. This bandwidth number assumes the specified minimum data transition density. Maximum jitter at 0.2MHz is 0.05UI.
 20. The specified time includes the time required to forward the EI entry condition.
 21. BER per differential lane.

Serial PD Matrix for FB-DIMM

Byte No.	Function described	Byte value	Hex value
0	Number of serial PD bytes written / SPD device size / CRC coverage	116	92H
1	SPD revision	Revision 1.1	11H
2	Key byte / DRAM device type	DDR2 SDRAM FB-DIMM	09H
3	Voltage levels of this assembly	VDD = 1.8V, VCC = 1.5V	12H
4	SDRAM addressing	14-row, 11-column	48H
5	Module physical attributes	8.2mm	24H
6	Module Type / Thickness	FB-DIMM	07H
7	Module organization	2 ranks / 4bits	10H
8	Fine timebase (FTB) dividend / divisor		00H
9	Medium timebase dividend	1	01H
10	Medium timebase divisor	4	04H
11	SDRAM minimum cycle time (tCK (min.)) -6E	3.00ns	0CH
	-5C	3.75ns	0FH
12	SDRAM maximum cycle time (tCK (max.))	8ns	20H
13	SDRAM /CAS latencies supported -6E	CL = 3, 4, 5	33H
	-5C	CL = 3, 4	23H
14	SDRAM minimum /CAS latencies time (tCAS)	15ns	3CH
15	SDRAM write recovery times supported -6E	WR = 2 to 5	42H
	-5C	WR = 2 to 4	32H
16	SDRAM write recovery time (tWR)	15ns	3CH
17	SDRAM write latencies supported	WL = 2 to 5	42H
18	SDRAM additive latencies supported	AL = 0 to 3	40H
19	SDRAM minimum /RAS to /CAS delay (tRCD)	15ns	3CH
20	SDRAM minimum row active to row active delay (tRRD)	7.5ns	1EH
21	SDRAM minimum row precharge time (tRP)	15ns	3CH
22	SDRAM upper nibbles for tRAS and tRC		00H
23	SDRAM minimum active to precharge time (tRAS)	45ns	B4H
24	SDRAM minimum auto-refresh to active /auto-refresh time (tRC)	60ns	F0H
25	SDRAM minimum refresh recovery time delay (tRFC), LSB	105ns	A4H
26	SDRAM minimum refresh recovery time delay (tRFC), MSB	105ns	01H
27	SDRAM Internal write to read command delay (tWTR)	7.5ns	1EH
28	SDRAM Internal read to precharge command delay (tRTP)	7.5ns	1EH
29	SDRAM burst lengths supported	BL = 4, 8	03H
30	SDRAM terminations supported	ODT = 50, 75, 150Ω	07H
31	SDRAM drivers supported	Supported	01H
32	SDRAM average refresh interval (tREFI) / double refresh mode bit / high temperature self-refresh rate support indication	7.8μs Double/HT refresh	C2H
33	Tcasemax (TC (max.)) delta / DT4R4W delta -6E	95°C/ 1.18°C	53H
	-5C	95°C/ 0.40°C	51H

Byte No.	Function described	Byte value	Hex value
34	Psi T-A SDRAM at still air	*3	xx
35	SDRAM DT0	*3	xx
36	SDRAM DT2Q	*3	xx
37	SDRAM DT2P	*3	xx
38	SDRAM DT3N	*3	xx
39	SDRAM DT4R / mode bit	*3	xx
40	SDRAM DT5B	*3	xx
41	SDRAM DT7	*3	xx
42 to 78	Reserved		00H
79	FB-DIMM ODT values	150Ω	22H
80	Reserved		00H
81 to 93	AMB personality bytes		xx
94 to 97	Reserved		00H
98	AMB junction temperature maximum (TJ (max.))		xx
99	Category byte	Planar/FDHS	0AH
100	Reserved		00H
101 to 116	AMB personality bytes		xx
117	Module ID: manufacturer's JEDEC ID code	Elpida Memory	02H
118	Module ID: manufacturer's JEDEC ID code	Elpida Memory	FEH
119	Module ID: manufacturing location		xx
120	Module ID: manufacturing date	Year code (BCD)	xx
121	Module ID: manufacturing date	Date code (BCD)	xx
122 to 125	Module ID: module serial number		xx
126 to 127	Cyclical redundancy code		xx
128 to 145	Module part number	EBE21FD4AGFD/N	xx
146	Module revision code	Initial	30H
147	Module revision code	(Space)	20H
148	SDRAM manufacturer's JEDEC ID code	Elpida Memory	02H
149	SDRAM manufacturer's JEDEC ID code	Elpida Memory	FEH
150	Informal AMB content revision tag (MSB)		xx
151	Informal AMB content revision tag (LSB)		xx
152 to 175	Manufacturer's specific data		00H
176 to 255	Open for customer use		00H

Remark IDD: DRAM current, ICC: AMB current

Notes: 1. Based on DDR2 SDRAM component specification.

2. Refer to JESD51-3 "Low effective thermal conductivity Test board for leaded surface mount packages" under JESD51-2 standard.

3. DT parameter is derived as following: $DT_x = IDD_x \times VDD \times \text{Psi T-A}$, where IDD_x definition is based on JEDEC DDR2 SDRAM component specification and at $VDD=1.9V$, it is the datasheet (worst case) value, and Psi T-A is the programmed value of Psi T-A (value in SPD Byte 33).

Physical Outline

Unit: mm

Front side

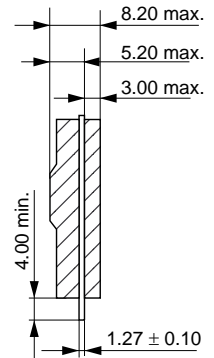
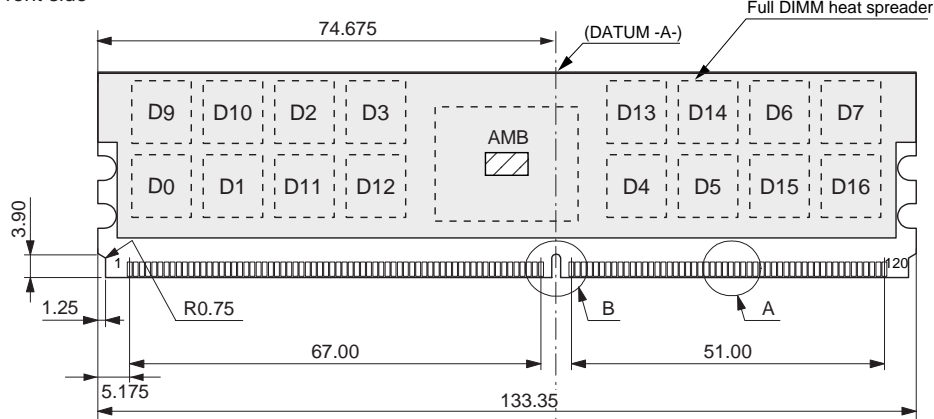

Back side

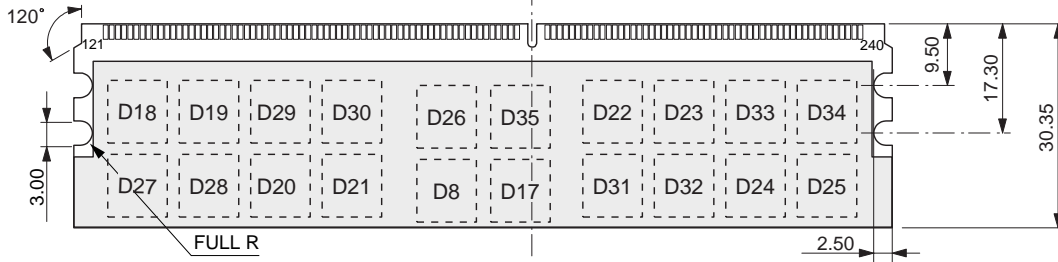

Detail A

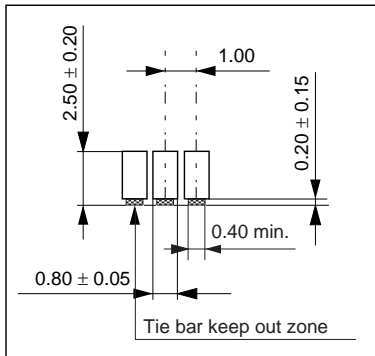

Detail B

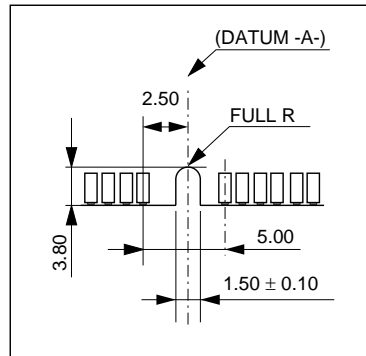

ECA-TS2-0172-01

CAUTION FOR HANDLING MEMORY MODULES

When handling or inserting memory modules, be sure not to touch any components on the modules, such as the memory ICs, chip capacitors and chip resistors. It is necessary to avoid undue mechanical stress on these components to prevent damaging them.

In particular, do not push module cover or drop the modules in order to protect from mechanical defects, which would be electrical defects.

When re-packing memory modules, be sure the modules are not touching each other.

Modules in contact with other modules may cause excessive mechanical stress, which may damage the modules.

MDE0202

NOTES FOR CMOS DEVICES**① PRECAUTION AGAINST ESD FOR MOS DEVICES**

Exposing the MOS devices to a strong electric field can cause destruction of the gate oxide and ultimately degrade the MOS devices operation. Steps must be taken to stop generation of static electricity as much as possible, and quickly dissipate it, when once it has occurred. Environmental control must be adequate. When it is dry, humidifier should be used. It is recommended to avoid using insulators that easily build static electricity. MOS devices must be stored and transported in an anti-static container, static shielding bag or conductive material. All test and measurement tools including work bench and floor should be grounded. The operator should be grounded using wrist strap. MOS devices must not be touched with bare hands. Similar precautions need to be taken for PW boards with semiconductor MOS devices on it.

② HANDLING OF UNUSED INPUT PINS FOR CMOS DEVICES

No connection for CMOS devices input pins can be a cause of malfunction. If no connection is provided to the input pins, it is possible that an internal input level may be generated due to noise, etc., hence causing malfunction. CMOS devices behave differently than Bipolar or NMOS devices. Input levels of CMOS devices must be fixed high or low by using a pull-up or pull-down circuitry. Each unused pin should be connected to V_{DD} or GND with a resistor, if it is considered to have a possibility of being an output pin. The unused pins must be handled in accordance with the related specifications.

③ STATUS BEFORE INITIALIZATION OF MOS DEVICES

Power-on does not necessarily define initial status of MOS devices. Production process of MOS does not define the initial operation status of the device. Immediately after the power source is turned ON, the MOS devices with reset function have not yet been initialized. Hence, power-on does not guarantee output pin levels, I/O settings or contents of registers. MOS devices are not initialized until the reset signal is received. Reset operation must be executed immediately after power-on for MOS devices having reset function.

CME0107

The information in this document is subject to change without notice. Before using this document, confirm that this is the latest version.

No part of this document may be copied or reproduced in any form or by any means without the prior written consent of Elpida Memory, Inc.

Elpida Memory, Inc. does not assume any liability for infringement of any intellectual property rights (including but not limited to patents, copyrights, and circuit layout licenses) of Elpida Memory, Inc. or third parties by or arising from the use of the products or information listed in this document. No license, express, implied or otherwise, is granted under any patents, copyrights or other intellectual property rights of Elpida Memory, Inc. or others.

Descriptions of circuits, software and other related information in this document are provided for illustrative purposes in semiconductor product operation and application examples. The incorporation of these circuits, software and information in the design of the customer's equipment shall be done under the full responsibility of the customer. Elpida Memory, Inc. assumes no responsibility for any losses incurred by customers or third parties arising from the use of these circuits, software and information.

[Product applications]

Elpida Memory, Inc. makes every attempt to ensure that its products are of high quality and reliability. However, users are instructed to contact Elpida Memory's sales office before using the product in aerospace, aeronautics, nuclear power, combustion control, transportation, traffic, safety equipment, medical equipment for life support, or other such application in which especially high quality and reliability is demanded or where its failure or malfunction may directly threaten human life or cause risk of bodily injury.

[Product usage]

Design your application so that the product is used within the ranges and conditions guaranteed by Elpida Memory, Inc., including the maximum ratings, operating supply voltage range, heat radiation characteristics, installation conditions and other related characteristics. Elpida Memory, Inc. bears no responsibility for failure or damage when the product is used beyond the guaranteed ranges and conditions. Even within the guaranteed ranges and conditions, consider normally foreseeable failure rates or failure modes in semiconductor devices and employ systemic measures such as fail-safes, so that the equipment incorporating Elpida Memory, Inc. products does not cause bodily injury, fire or other consequential damage due to the operation of the Elpida Memory, Inc. product.

[Usage environment]

This product is not designed to be resistant to electromagnetic waves or radiation. This product must be used in a non-condensing environment.

If you export the products or technology described in this document that are controlled by the Foreign Exchange and Foreign Trade Law of Japan, you must follow the necessary procedures in accordance with the relevant laws and regulations of Japan. Also, if you export products/technology controlled by U.S. export control regulations, or another country's export control laws or regulations, you must follow the necessary procedures in accordance with such laws or regulations.

If these products/technology are sold, leased, or transferred to a third party, or a third party is granted license to use these products, that third party must be made aware that they are responsible for compliance with the relevant laws and regulations.

M01E0107